

BUZZ

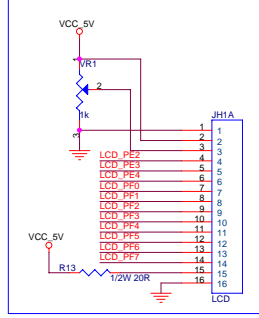

LCD Part

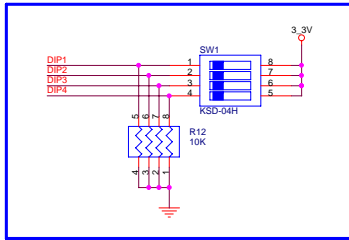

DIP Switch

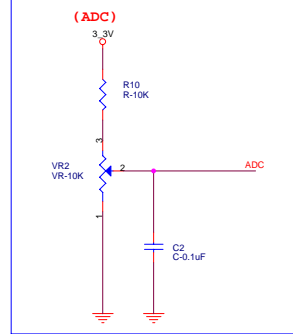

ADC

Bypass Condensor

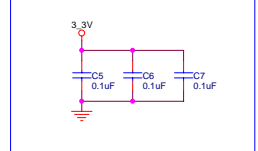

AVR Download Port

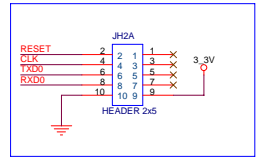

Ext Switch

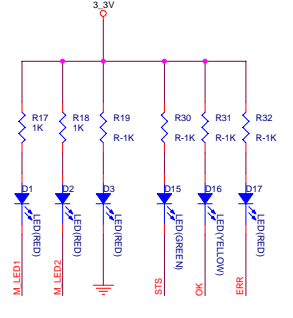
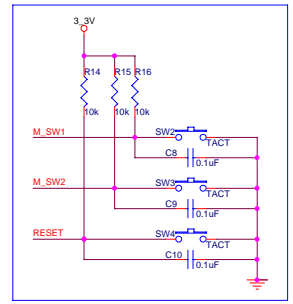

LED

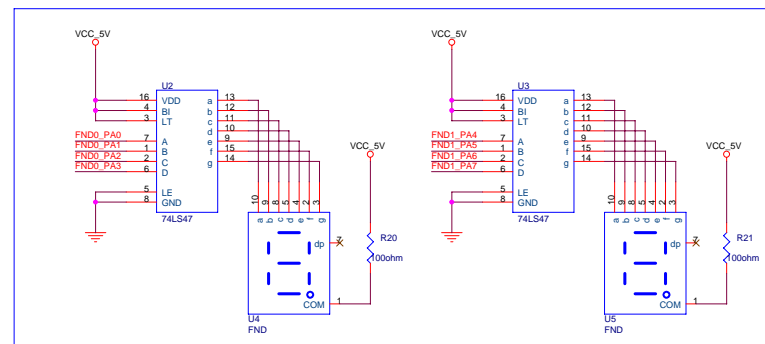

FND

Power

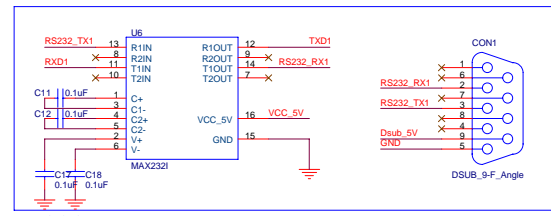
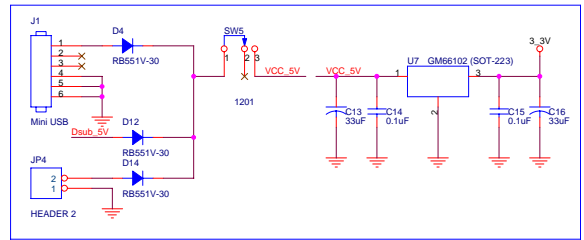

RS232

File	<Title>	Rev	<RevCode>
Size	Document Number		
Date	Saturday, November 15, 2008	Sheet	1 of 1