

입력전압(VCC)이 5V 이상일때 R2 저항을 제거해주시고 R3에 0ohm을연결해주시기바랍니다.

입력전압(VCC)이 3.3V 일때 R2 저항에 0ohm 연결해주시고 R3저항을 제거해 주시기 바랍니다.

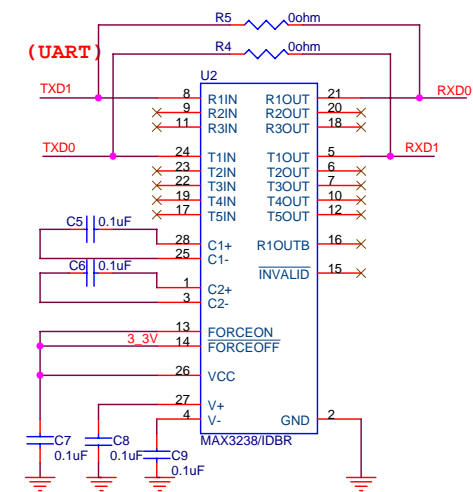
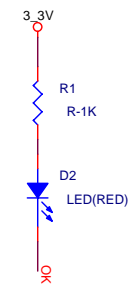
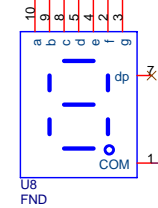
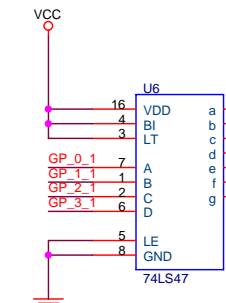
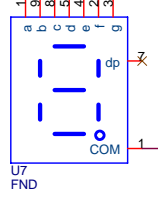
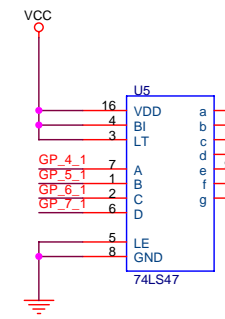
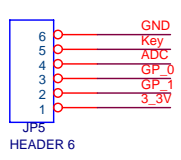
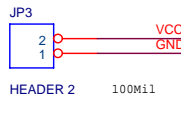
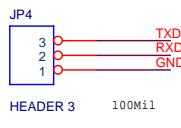
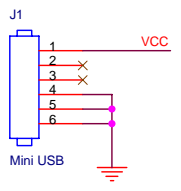

FZ800ED\_GPIO\_FND의 JP4를 통해서 출력되는 신호를 EIA Level로 사용하실려면 R4,R5의 연결을 끊어주시고 U2(MAX3238)와 C5,C6,C7,C8,C9에 각각 0.1uF를 연결하시기바랍니다.

FZ800ED\_GPIO\_FND의 JP4를 통해서 출력되는 신호를 TTL Level로 사용하실려면 R4,R5에 0ohm을 연결해주시고 U2, C5,C6,C7,C8,C9를 제거해주시기바랍니다.

Title		
FZ800ED_GPIO_FND		
Size	Document Number	Rev
B	<Doc>	<RevCode>
Date:	Tuesday, November 11, 2008	Sheet 1 of 1